

seesky bio[®]

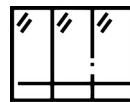

Expanding spaces and
views without limits



**GLASS WALLS
& DOORS LTD.**

EXCEPTIONAL DOORS FOR EXCEPTIONAL HOMES



Bioclimatic pergola **seesky-bio**

Seesky-BIO is a pergola system which allows to increase living areas without any additional construction work, and it is a perfect solution for terraces, gardens, hotels and restaurants.

Thanks to the pergola's motor and numerous sensors, pergola closes protecting the inside as harsh weather conditions are detected, so it can be used all year around.

Seesky-Bio also offers different options for extra comfort (LED lights, music, heaters, ...) that can be controlled by control remote, *Smartphone* or *Tablet*.

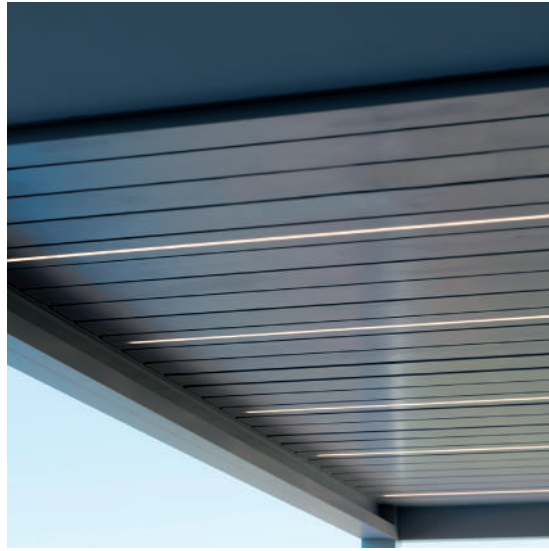

Ventilation



Rain Protection



Sun Protection



Automation

FUNCTIONALITY



VENTILATION

Temperature can be controlled in a natural way thanks to oriented motorized slats (45°, 90° and 135°), that allow the air to come in during summertime as they are opened, and retaining the heat during winter when slats remain closed.



SUN PROTECTION

You can adjust aluminum slats orientation either by control remote or using Smartphone and Tablet, as well as program the pergola, in this way you can achieve a complete protection against sun radiation.

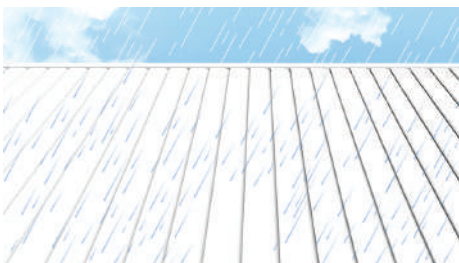

RAIN PROTECTION

Specially designed roof aluminum slats collect water and using a pipeline system take collected water through lateral columns to the outside.

ROTATIVE ALUMINUM

The system of rotative aluminum slats controlled either by remote or using Smartphone and Tablet.

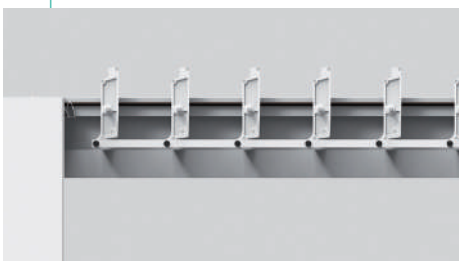
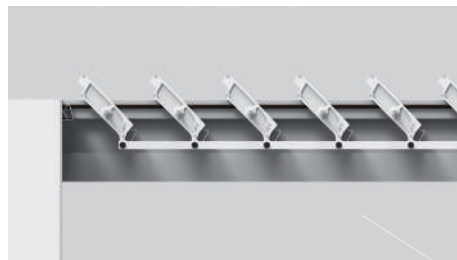
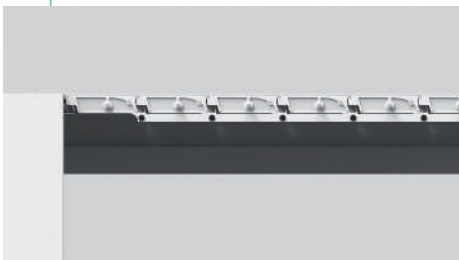

TECNICAL DETAILS



50MM PIPELINE DRAINAGE *OPTIONAL*
System for water evacuation through columns.

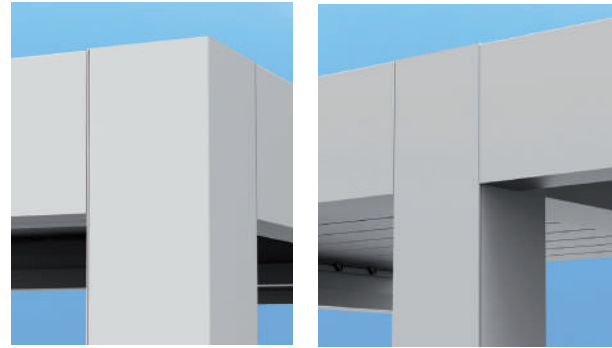

UNION BEAMS AND PERGOLA CONNECTION
The union of beams with pergola's structure does not disrupt structure aesthetics, as the union of these elements has a clean and elegant finish. Seesky-BIO only needs one column for the union of successive pergolas, what adds extra useable space as well as reduces visual impact.



ANTISPLASH SYSTEM (PATENTED)
Seesky Bio features a modern antisplashing system for inside protection and dirt collection.

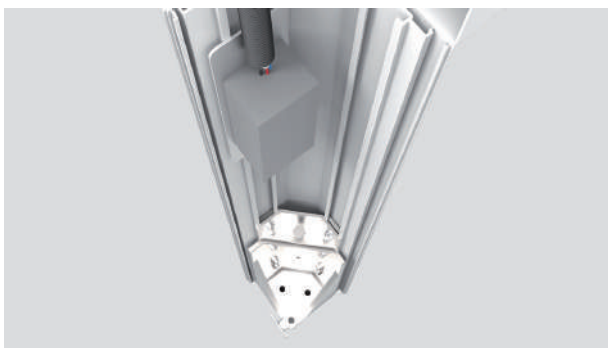

RECORDABLE COLUMN
The installation and maintenance of pergola is very easy and comfortable thanks to the recordable column.
This option is very useful where there is not much space to tighten screws and adjust inside cables.



SLATS WITH POLYSTYRENE *Optional*
Adding polystyrene into slats allows us to create a sound isolation when it rains.

VARIETY OF CONFIGURATIONS

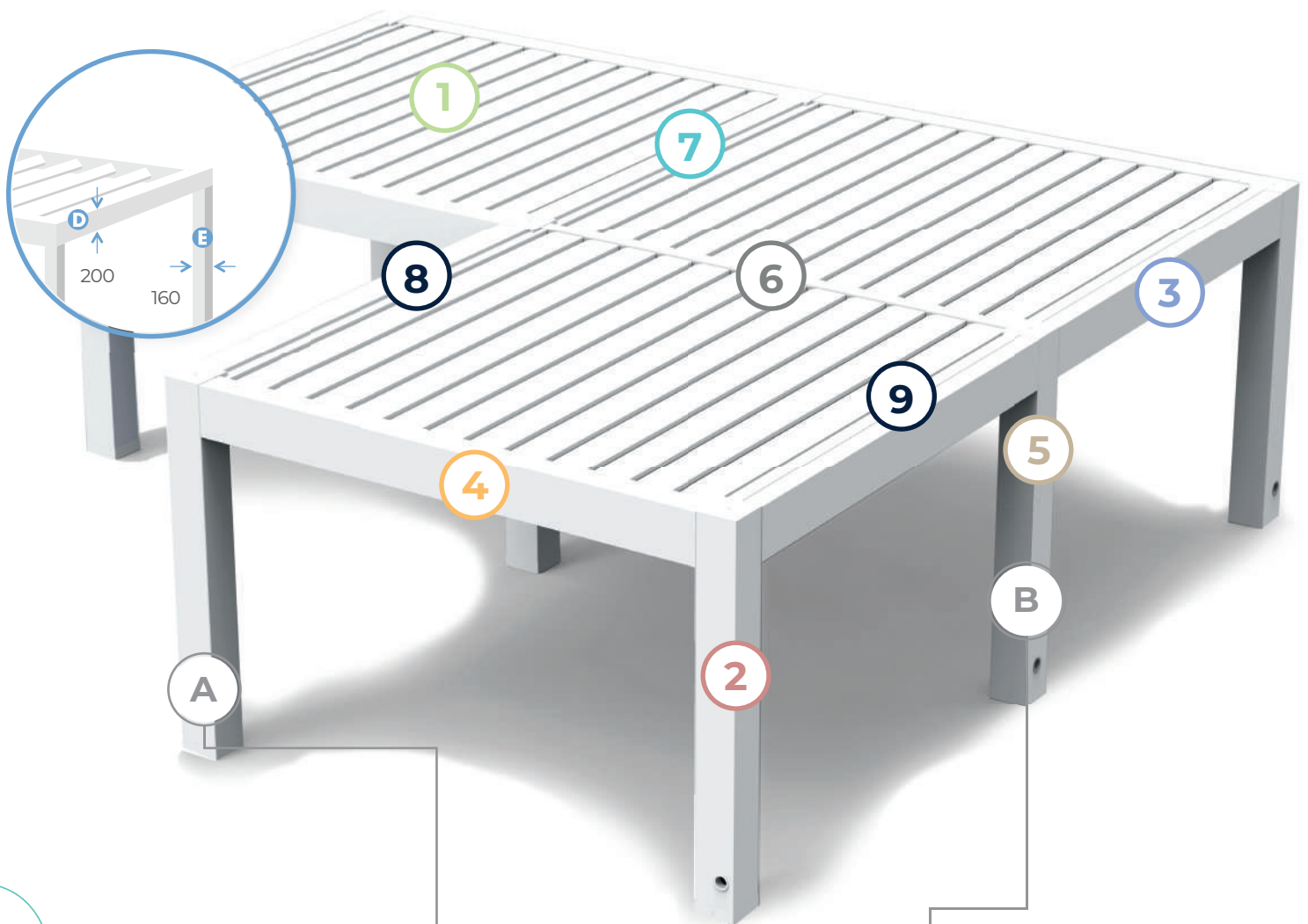

A-SUPPORT TYPES
Fixed and Adjustable



B-DRAINAGE TYPES
Free or Pipeline

BEAM AND SLAT SECTIONS

1 SLAT

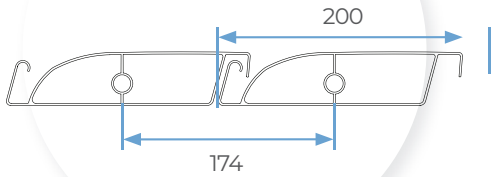

2 RECORDABLE COLUMN

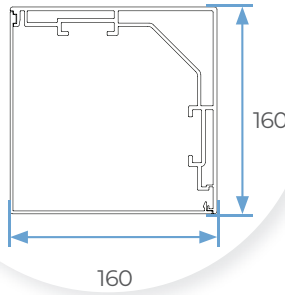

3 FRONT BEAM

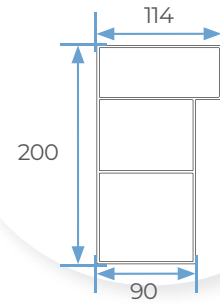

4 LATERAL BEAM

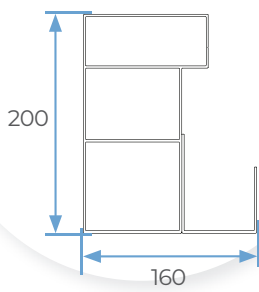

5 UNION COLUMN

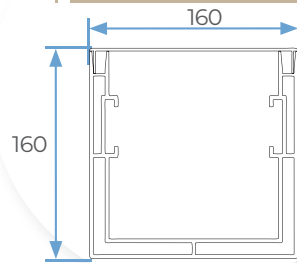

6 CENTRAL BEAM

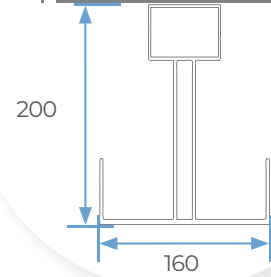

7 UNION BEAMS

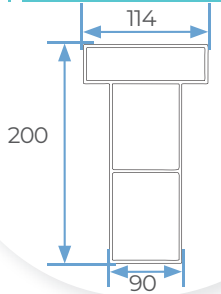

8 FRONT SLAT COVER

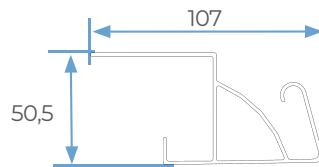

9 BACK SLAT COVER

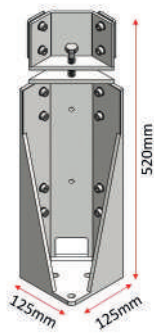
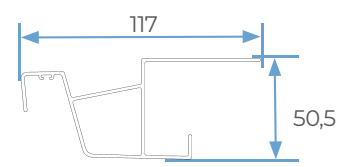

Adjustable Reinforced Support

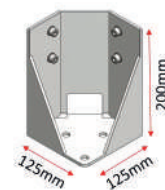

Adjustable Support

MAXIMUM DIMENSIONS

Seesky-bio can be custom made using different variations, depending on where the installation will take place so it can be adapted to customer's needs.

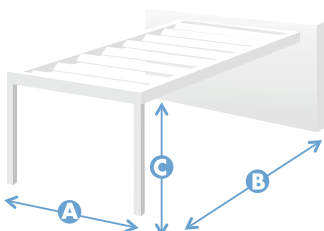
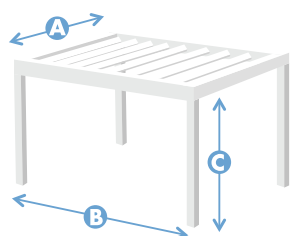

4 OR 2 COLUMNS

A	Maximum width	4.000 mm
B	Maximum length	6.450 mm
C	Maximum height	3.000 mm

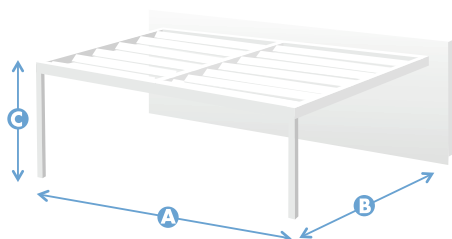
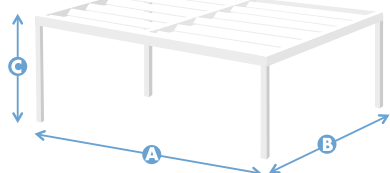

DUPLEX
4 OR 2 COLUMNS

A	Maximum width	6.500 mm
B	Maximum length	6.450 mm
C	Maximum height	3.000 mm

VARIETY OF CONFIGURATIONS

Seesky-bio can be custom made using different variations, depending on where the installation will take place so it can be adapted to customer's needs. There are 4 different configurations.

A ISLAND

The most common configuration, installed with 4 columns.

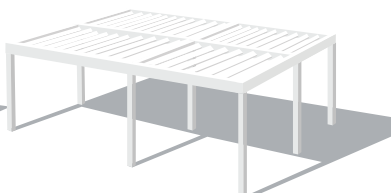
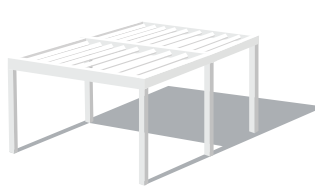

B PORTICO

Mixed configuration of 2 types of supports: columns and wall supports.

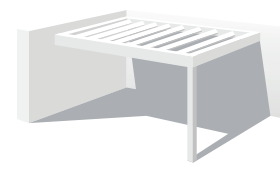
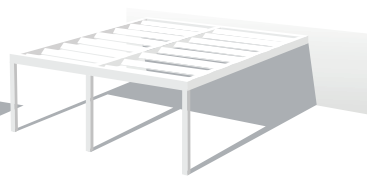

C INBETWEEN CONFIGURATION (WITHOUT COLUMNS)

For this configuration only wall supports are used.

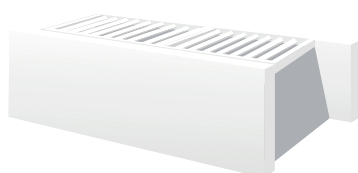

D DUPLEX

Pergola connection without intermediate columns.

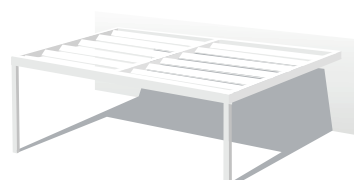



AUTOMATION

With seesky BIO intelligent automation "T-MATE", you will obtain a maximum comfort as pergola can be controled or prgrammed through Bluetooth, *smartphone* or *tablet*, making it as another autotion house device.



ILLUMINATION

There are 4 different illumination options available:

- Spot lights
- LED strips
- Perimetral LED
- Beam spot lights

Thanks to "T-MATE", illumination pack can be programmed for switching on and off at any time, and for controlling light intensity.

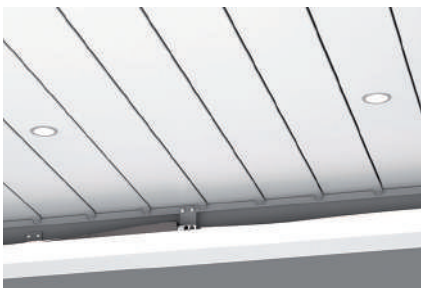



SOUND PACK

Sound integrated system allow you to listen to your favorite music with a direct radio access, USB adaptor and Bluetooth. Speakers can be provided in white or black color. Sound system can be controlled with control remote (not the same that controls slats opening), *mobile phone* or *tablet*.



INFRARED HEATERS

Seesky-bio can be combined with infrared heater **habitat-hot**, so you can enjoy a pleasant temperature even on very cold winter days. **Habitat-hot** heater can be controlled using the same remote control as you use for slat opening.

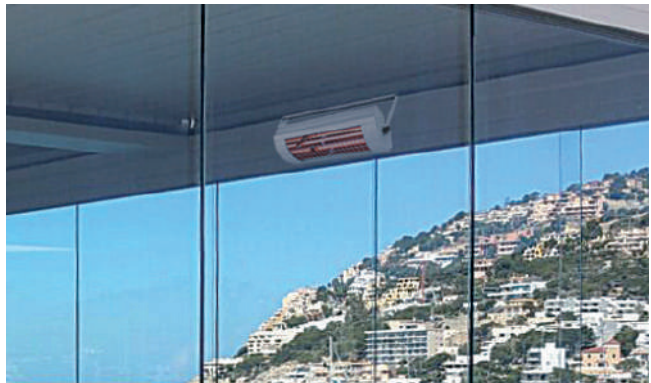

AUTOMATIC SENSORS

Thanks to rain and wind sensors the inside of the pergola **seesky-bio** is automatically protected against harsh weather conditions.

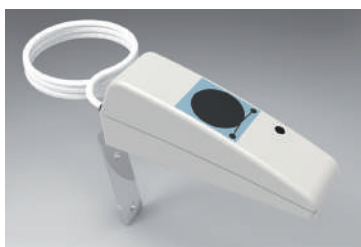

Rain Sensor



Wind sensor



Ice/Snow Sensor

SKY-LIGHT OPTION

This option adds resistance to the pergola structure as at the same time allows to brighten the inside without having to open all the slats.

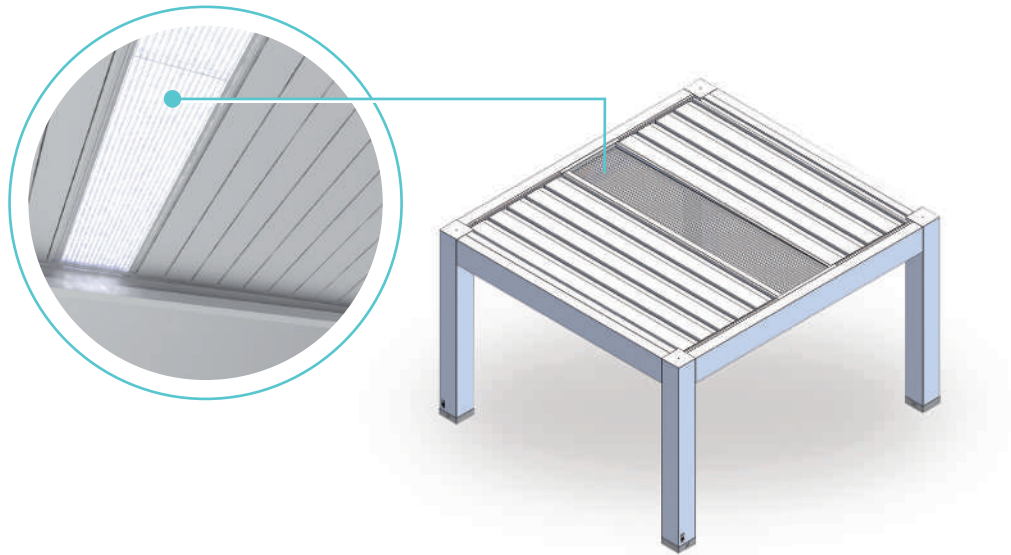

OPTION SHIFTEN COLUMN

Pergola can be adapted to existing structures thanks to shifted column option (maximum 1000 mm).



OPTION CABLE ATTACHMENT

There is a possibility of fastening pergola to the wall and allowing an installation without columns.

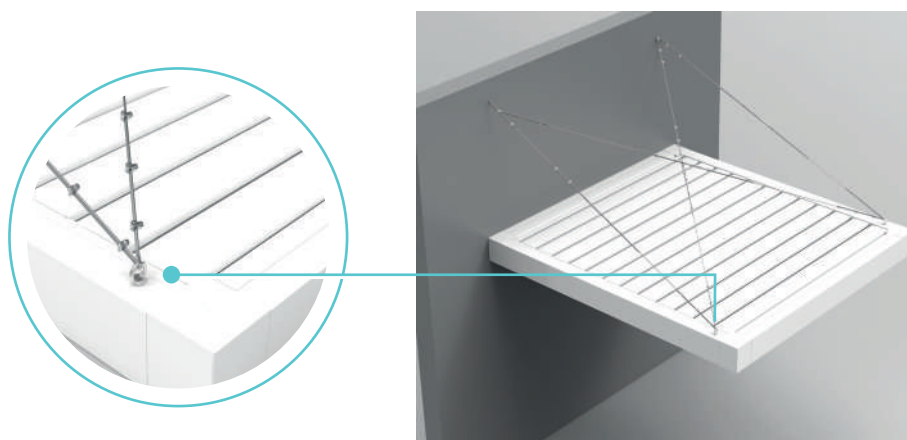

SLIDING AND FOLDING GLAZING SYSTEMS

seeglass one

With sliding and folding system **seeglass-one** you will protect the inside pergola without giving up the view and to open everything completely.

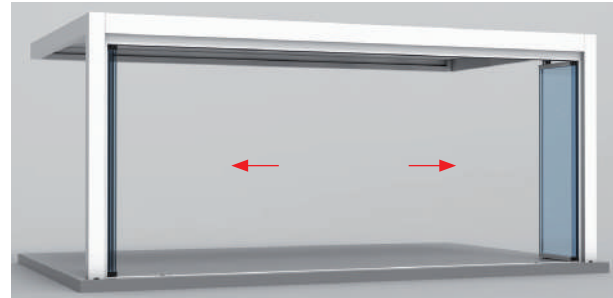

For information related to hanging glazing systems **seeglass one**, compatibility, please consult the table on page 15.

SLIDING GLAZING SYSTEM

seeglass run

With sliding system **seeglass-run** you will protect the inside of the pergola without invading interior space.

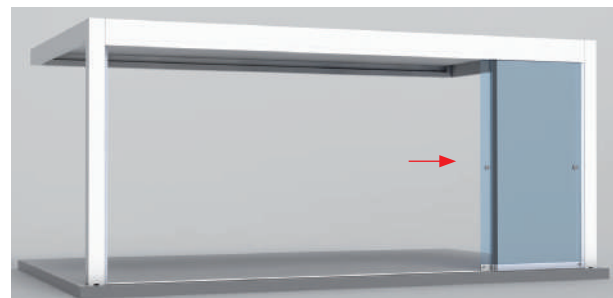
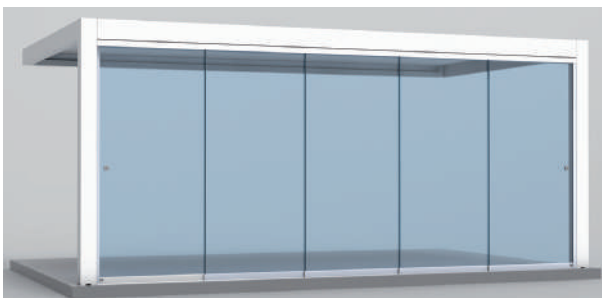

ADJUSTABLE WIND SCREENS

habitat win

Combined with adjustable windscreen **habitat-win**, protect the inside from windy weather.

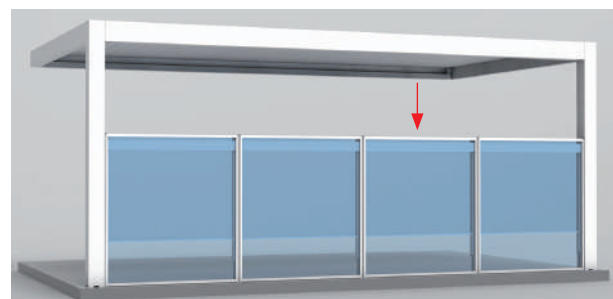
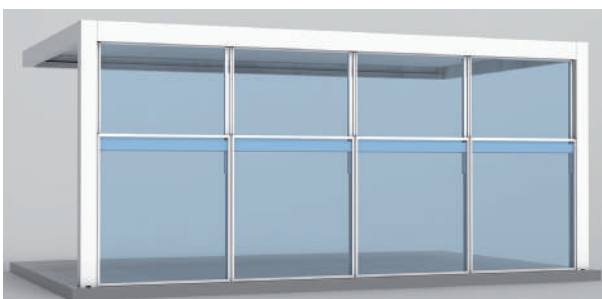

SUN PROTECTING ZIP SCREEN

habitat zip®

Sun protecting zip screens allow to protect the inside of the pergola from excessive heat and wind.

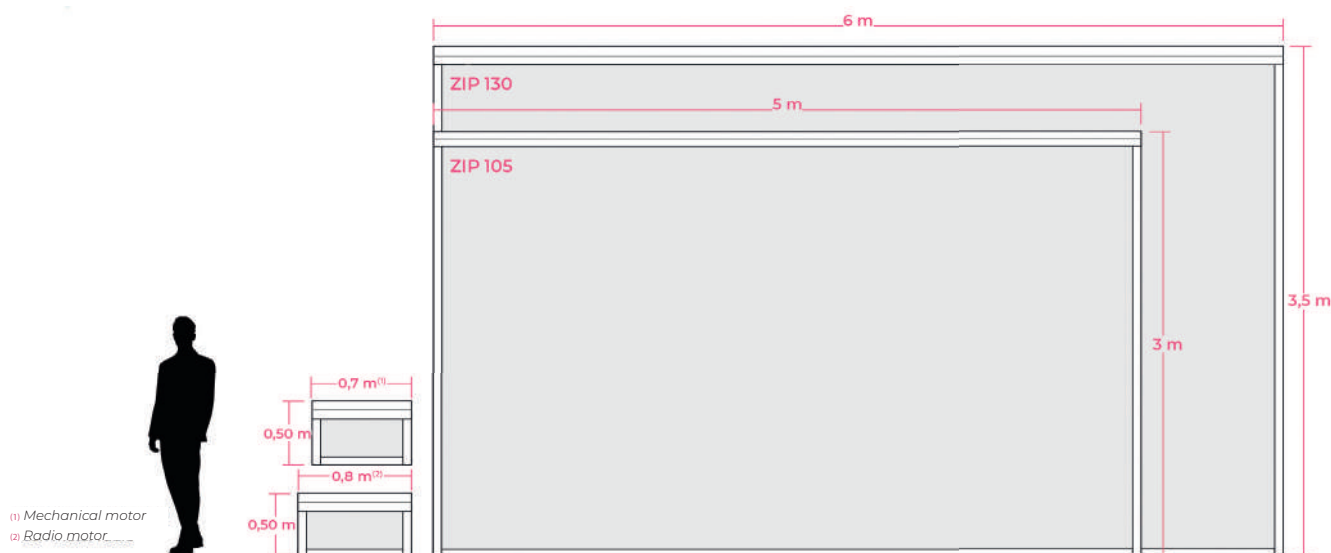
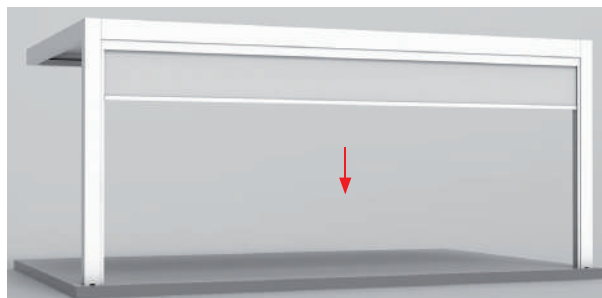

MOSQUITO NET

habitat net®

Combine mosquito screen **habitat-net** with your pergola and you are going to be able to yourself from different kinds of insects. With a minimalistic design and simple functioning, it will be a perfect complement for your pergola.

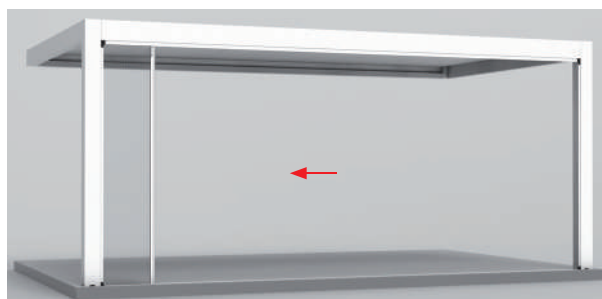

TESTING **

Seesky-bio has all the necessary certificates issued by official corresponding agencies.

WIND
Resistance



Wind Loads UNE EN 13659:2016
CLASS 6

WATER-
TIGHTNESS



Watertightness UNE EN1873.2006 SECT. 6.3
SATISFACTORY

SNOW
RESISTANCE



Snow resistance internal methodology
252,01 kg/m2***

SOLAR
TRANSFER
FACTOR



Transmission of solar energy: 0,15
according to index GTot EN 14501

CERTIFICATES

Our pergola has all the necessary certificates for aluminum treatment.



Standard white color,
available in other RAL colors,
ANODIZED OPTION NOT AVAILABLE.

* Check warranty conditions.

(For checking warranty details, please access general sales conditions, available in distributor area on the website).

** Installation not recommendable in places where 100% watertightness is recommended, as it is possible due to harsh meteorology conditions (rain with strong winds, hail, condensation, etc...) pipeline system obstruction, improper sealing, or other agents, could cause water entrance. C3 Systems will not held responsible for possible water entrance, damaged caused on goods and people.

*** Check the details of the tests on our website.